

twilight

INSTRUMENTOS DE MEDICIÓN INDUSTRIAL

Medidor de Rotación de Fase Digital Sin Contacto Metálico

HK-PD312910

www.twilight.mx

 / [twightsadecv](#)

 / [twightsadecv](#)

 / [twightsadecv](#)

HIOKI

PD3259

Instruction Manual

DIGITAL PHASE DETECTOR



EN

Apr. 2019 Revised edition 1
PD3259A981-01 19-04H



Contents

Introduction.....	1
Verifying Package Contents	1
Options (Sold Separately).....	2
Safety Information	2
Operating Precautions	7

1 Overview 13

1.1 Overview and Features	13
1.2 Part Names and Functions	14
1.3 Battery Level.....	17

2 Preparing for Measurement 19

2.1 Measurement Process	19
2.2 Attaching Color Spirals and Bundling Cables Together	20
2.3 Attaching the Magnetic Strap (Optional)	21
2.4 Installing and Replacing Batteries	22
2.5 Inspecting the Instrument	23
2.6 Turning the Instrument On and Off.....	24
2.7 Attaching the Voltage Sensors to the Circuit.....	25
2.8 Setting Up the Instrument in the Measurement Location	28

3 Performing Measurement 29

3.1 Measuring Line Voltages in a 3-phase Circuit.....	30
3.2 Checking Phase Order in a 3-phase Circuit (Phase Detection Function)	32

3.3	Measuring Frequency	33
4	Convenient Uses	35
4.1	Power-on Options	35
	Auto power-off function	37
	Disabling the auto-power-off function	38
	Switching the phase display (phase display switching function)	39
	Enabling and disabling the beep function	40
	Checking the version and serial number	41
4.2	Holding the Display	42
	Enabling and disabling the hold function	42
4.3	Turning On the Backlight	43
	Enabling and disabling the backlight	43
4.4	Displaying the Predicted State for a 3-phase Circuit	44
5	Specifications	45
5.1	General Specifications	45
5.2	Input Specifications and Measurement Specifications	46
	Accuracy specifications	47
5.3	Functional Specifications	47
5.4	Other Specifications	48
6	Maintenance and Service	49
6.1	Repair, Inspection, and Cleaning	49
6.2	Troubleshooting	50
	Error codes	53

Appendix **Appx.1****Appx. 1 About 3-phase CircuitsAppx.1****Appx. 2 About the Instrument's Voltage
Sensors.....Appx.2****Index** **Ind.1**

Introduction

Thank you for choosing the Hioki PD3259 Digital Phase Detector. To obtain maximum performance from the instrument, please read this manual first, and keep it handy for future reference.

Verifying Package Contents

Once you have received the instrument, verify that it has not suffered any damage during shipment before using it. Pay particular attention to the accessories, panel keys, and cables. If damage is evident, or if it fails to operate according to the specifications, contact your authorized Hioki distributor or reseller.

Confirm that these contents are provided.

- PD3259**
Digital Phase Detector

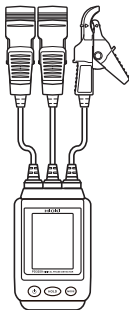

Accessories

- LR6 (AA-size) alkaline batteries × 4**



- Instruction manual**



- Carrying case**



- Spiral tubes**
(black × 1, red × 2, blue × 2, yellow × 2)



Options (Sold Separately)

The following options are available for this instrument. Contact your authorized Hioki distributor or reseller when ordering.

Z5020 Magnetic Strap (p.21)



The magnetic strap can be used to attach the instrument to a wall, such as a metal surface.

Safety Information

This instrument is designed to conform to IEC 61010 Safety Standards, and has been thoroughly tested for safety prior to shipment. However, using the instrument in a way not described in this manual may negate the provided safety features. Before using the instrument, be certain to carefully read the following safety notes.

CAUTION



- Mishandling during use could cause damage to the instrument. Be certain that you understand the instructions and precautions in the manual before use.
- Individuals using an electrical measuring instrument for the first time should be supervised by a technician who has experience in electrical measurement.

Protective gear







WARNING









This instrument measures live lines. To prevent electric shock, use appropriate protective insulation and adhere to applicable laws and regulations.

Safety-related notations



In this manual, the risk seriousness and the hazard levels are classified as follows.

 DANGER	Indicates an imminent hazard that could lead to serious injury or death.
 WARNING	Indicates a hazard that could lead to serious injury or death.
 CAUTION	Indicates a hazard that could lead to minor injury or that could be expected to result in equipment or other damage.
IMPORTANT	Indicates information related to the operation of the instrument or maintenance tasks with which the operators must be fully familiar.
	Indicates a strong magnetic-field hazard. The effects of the magnetic force can cause abnormal operation of heart pacemakers and/or medical electronics.
	Indicates a high-voltage hazard. Warns that failure to verify safety or improper use of the instrument could lead to electric shock, burns, or death.
	Indicates a prohibited action.
	Indicates the action which must be performed.
*	Additional information is presented below.
[]	Names of items on screens are enclosed in parentheses ([]).
MODE (Bold font)	Alphanumeric characters shown in bold indicate the characters that appear on the control keys.

Symbols displayed on the instrument

	Indicates cautions and hazards. When the symbol is printed on the instrument, refer to a corresponding topic in the Instruction Manual.
	Indicates an instrument that is completely protected by double insulation and reinforced insulation.
	Indicates the grounding terminal.
	Indicates DC (Direct Current).
	Indicates AC (Alternating Current).
	Indicates the power supply's "on" and "off" positions.

Symbols for various standards

	Indicates the Waste Electrical and Electronic Equipment Directive (WEEE Directive) in EU member states.
	Indicates that the product conforms to regulations set out by the EC Directive.

Characters in screen displays

The screen of this instrument displays characters in the following manner.

A	B	C	D	E	F	G	H	I	J	K	L	M	N	O	P	Q	R	S	T	U	V	W	X	Y	Z
A	b	C	d	E	F	G	H		J	K	L	ñ	no	P	q	r	S	t	U	u	y	Y	z		

1	2	3	4	5	6	7	8	9	0
1	2	3	4	5	6	7	8	9	0

Accuracy

We define measurement tolerances in terms of rdg. (reading) and dgt. (digit) values, with the following meanings:

rdg.	(Reading or displayed value) The value currently being measured and indicated on the measuring instrument.
dgt.	dgt. (resolution) The smallest displayable unit on a digital measuring instrument, i.e., the input value that causes the digital display to show a “1” as the least-significant digit.

Measurement categories

To ensure safe operation of measurement instruments, IEC 61010 establishes safety standards for various electrical environments, categorized as CAT II to CAT IV, and called measurement categories.

DANGER



- Using a measuring instrument in an environment designated with a higher numbered category than that for which the instrument is rated could result in a severe accident, and must be carefully avoided.
- Using a measuring instrument without categories in an environment designated with the CAT II to CAT IV category could result in a severe accident, and must be carefully avoided.

This instrument conforms to the safety requirements for CAT IV 600 V measuring instruments.

- CAT II: When directly measuring the electrical outlet receptacles of the primary electrical circuits in equipment connected to an AC electrical outlet by a power cord (portable tools, household appliances, etc.)
- CAT III: When measuring the primary electrical circuits of heavy equipment (fixed installations) connected directly to the distribution panel, and feeders from the distribution panel to outlets
- CAT IV: When measuring the circuit from the service drop to the service entrance, and to the power meter and primary overcurrent protection device (distribution panel)

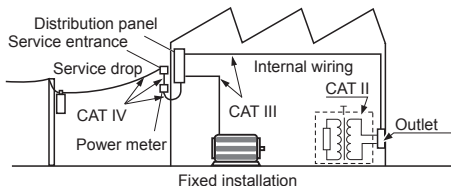

Operating Precautions

Follow these precautions to ensure safe operation and to obtain the full benefits of the various functions.

Ensure that your use of the product falls within the specifications not only of the instrument itself, but also of any accessories, options, batteries, and other equipment being used.

WARNING



Do not use the instrument beyond its rated and specification ranges. Doing so may result in damage to the instrument or electric shock.

Before using the instrument, check the instrument for any damage that may have been sustained while in storage or transit, inspect it, and verify that it is operating properly. If you find any faults, contact your authorized Hioki distributor or reseller.

This instrument may cause interference if used in residential areas. Such use must be avoided unless the user takes special measures to reduce electromagnetic emissions to prevent interference to the reception of radio and television broadcasts.

Installation

DANGER



Persons wearing electronic medical devices such as a pacemaker should not use the Z5020 Magnetic Strap. Such persons should avoid even proximity to the Z5020 Magnetic Strap, as it may be dangerous. The medical device's operation could be compromised, posing risk to the wearer's life.

WARNING

Avoid the following locations that could cause an accident or damage to the instrument.



- Exposed to direct sunlight or high temperature
- Exposed to corrosive or combustible gases
- Exposed to a strong electromagnetic field or electrostatic charge
- Near induction heating systems (such as high-frequency induction heating systems and IH cooking equipment)
- Subject to vibration
- Exposed to water, oil, chemicals, or solvents
- Exposed to high humidity or condensation
- Exposed to high quantities of dust particles

Handling of the instrument

DANGER



To prevent electric shock, do not touch any areas beyond the barrier while the instrument is in use.

⚠ CAUTION

To avoid damage to the instrument, protect it from physical shock when transporting and handling. Be especially careful to avoid physical shock from dropping.

After use, always turn OFF the power.

Handling of the cables**⚠ WARNING**

To prevent electric shock, verify that the interior of the cable is not exposed. If any color is visible from the inside of the cable, do not use the instrument.

⚠ CAUTION

- Avoid stepping on or pinching cables, which could damage the cables insulation.
- To prevent damage due to snapped wires, do not bend or pull the base of the voltage sensor or cables.



The cable is hardened under the 0 degree or colder environment. Do not bend or pull it to avoid tearing its shield or cutting cable.

Precautions when transporting the instrument**⚠ CAUTION**

During shipment of the instrument, handle it carefully so that it is not damaged due to a vibration or shock.

Batteries

WARNING



Battery may explode if mistreated. Do not short circuit, recharge, disassemble or dispose of in fire.



To prevent instrument damage or electric shock, use only the screws (M3 × 8 mm) for securing the battery cover in place that are originally installed. If you have lost any screws or find that any screws are damaged, please contact your authorized Hioki distributor or reseller for a replacement.

CAUTION

Heed the following instructions to avoid battery performance drop or leakage.



- Do not mix old and new batteries, or different types of batteries.
- Pay attention to the polarity markings “+–”, so that you do not insert the batteries the wrong way around.
- Do not use batteries after their recommended expiry dates.
- Do not leave a depleted battery inside the instrument.
- Replace batteries only with the specified type.
- Remove the batteries and store them if the instrument will not be in use for a long time.

- Handle and dispose of batteries in accordance with local regulations.
-  flashes when the batteries are low. In this case, the accuracy of the instrument is not guaranteed. Therefore, the batteries should be replaced as soon as possible.

Handling the voltage sensor

IMPORTANT

If the measurement target is an insulated wire with dirt or moisture on its insulation, the instrument may display lower values than the actual voltage. If the surface of the measurement target's insulation has dirt or moisture on it, wipe it clean with a dry cloth before measurement.

1

Overview

1.1 Overview and Features

The PD3259 is a phase detector equipped with a voltmeter, enabling it to be used to measure line voltages, check phase order, measure frequency, and check for live wires and the ground phase in 3-phase circuits.

By letting users check the state of 3-phase circuits at a glance, the instrument delivers a high level of safety. In addition, because it lets users measure line voltages, verify that wires are live, and check phase voltages and the ground phase at once, it eliminates wiring errors and reduces work times.

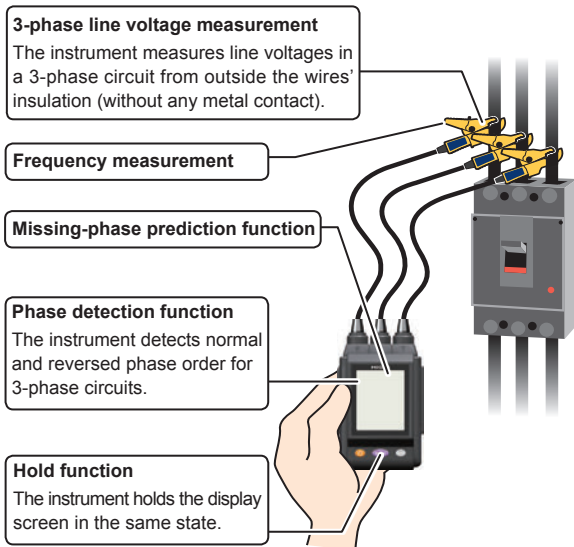

1.2 Part Names and Functions

Front

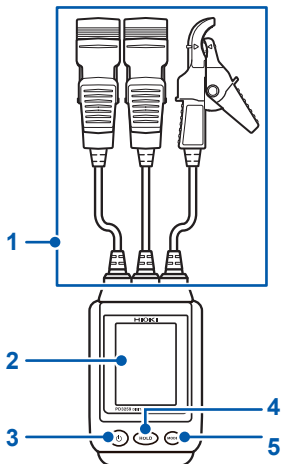

Rear

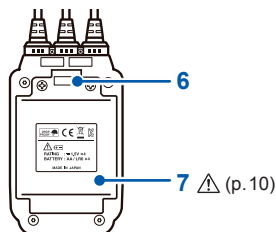

1	Voltage sensor	p.25
2	Display	p. 16
3	POWER	p.24
4	HOLD Allows the user to manually hold the detection results and measured values being shown on the display.	p.42
5	MODE Switches modes.	–
6	Strap slot	p.21
7	Battery cover	p.22

Voltage sensors

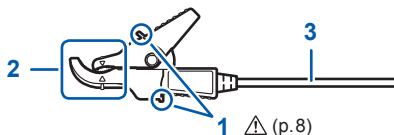

1	Barriers To avoid electric shock, avoid touching the part of the sensor beyond these barriers during use.	p.25
2	Clip Attach the clip to the wire being measured, taking care to align the position of the measurement target with the marks.	p.25
3	Cable	-



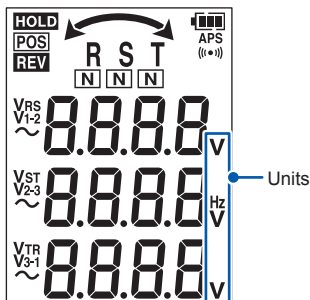

Display



HOLD	Phase detection results and measured value hold (p.42)
((••))	Phase detection tone enabled (p.32)
APS	Auto-power-off function enabled (p.37)
	Battery level (p.17)
R S T (1 2 3)	Phase display as either R/S/T or 1/2/3 (user-switchable) When a phase is missing, the indicator for that phase will turn off (missing-phase prediction function)
$V_{RS}(V_{1-2})$	Line voltage V_{RS} (V_{1-2}) (p.30)
$V_{ST}(V_{2-3})$	Line voltage V_{ST} (V_{2-3}) (p.30)
$V_{TR}(V_{3-1})$	Line voltage V_{TR} (V_{3-1}) (p.30)
~	AC current
POS	Normal (positive) phase sequence order detected when checking the phase order for a 3-phase circuit
REV	Reversed (negative) phase sequence order detected when checking the phase order for a 3-phase circuit
N	Ground phase predicted in a 3-phase/3-wire circuit
	Normal or reversed phase order when checking the phase order for a 3-phase circuit

1.3 Battery Level

Battery level display

	There is adequate battery power remaining.
	The graduations in the indicator disappear from the left as the battery's power falls.
	Soon no battery power will remain. Have new batteries ready.
	On continuously No battery power remains. Replace the batteries with new batteries immediately.
	Flashing No battery power remains. Replace the batteries with new batteries immediately. Continued use may cause power to the instrument to be interrupted. Measurement accuracy cannot be guaranteed in this state.

The battery level display provides a rough guideline of how much continuous operating time remains. When using lithium batteries, the battery level indicator does not function properly.

Interruption of power



When the indicator shows no remaining battery power (🔋 flashing), the display will indicate **[bAtt Lo]** for 2 seconds, and the instrument will turn off.

2

Preparing for Measurement

2.1 Measurement Process

Before using the instrument, be sure to read “Operating Precautions” (p.7).

Setting up, connecting, and turning on the instrument

Turn on the instrument (p.22)

Inspect the instrument (p.23)

Turn on the instrument (p.24)

Arrange to use other options as needed.

Connect voltage sensors (p.25)

Performing measurement

Measure the circuit (p.29)

- Measuring line voltages in a 3-phase circuit (p.30)
- Checking phase order in a 3-phase circuit (phase detection) (p.32)
- Measuring the frequency (p.33)

Hold measured values and phase order detection results (p.42)

Finishing using the instrument

Turn off the instrument (p.24)

2.2 Attaching Color Spirals and Bundling Cables Together

Procedure

- 1** To aid in differentiating the voltage sensors, attach the included color spirals (red, blue, and yellow) to both cables of the voltage sensor side and instrument side.
- 2** Bundle the voltage sensor cables together with the included spiral (black).

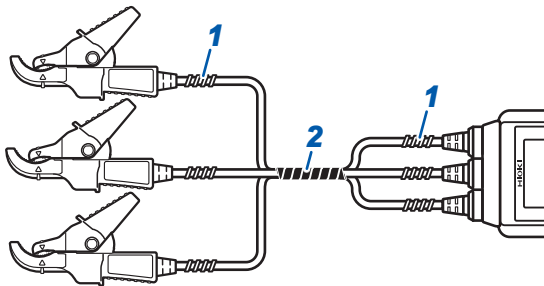

The colors used to identify phases vary by country and region. Use the included color spirals (red, blue, and yellow) to differentiate the voltage sensors as necessary.

2.3 Attaching the Magnetic Strap (Optional)

When the optional Z5020 Magnetic Strap is attached to the instrument, the magnetic portion can be used to hold the instrument in place on steel sheet and other magnetic surfaces.

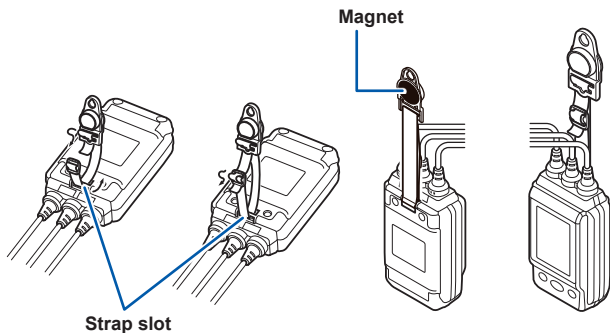

2.4 Installing and Replacing Batteries

When using the instrument, install four LR6 (AA-size) alkaline batteries. Verify that sufficient battery strength remains before measurement. If there is insufficient battery power remaining, replace the batteries (p. 17).

You will need

- A screwdriver
- LR (AA-size) alkaline batteries × 4

Procedure

- 1** Press **POWER** to turn off the instrument.
- 2** Untighten the screws that holds the battery cover in place with the screwdriver and remove the cover.
- 3** If replacing the batteries, remove all old batteries.
- 4** Install four new batteries, taking care to orient them properly.
- 5** Reattach the battery cover and tighten the screw (M3 × 8 mm).

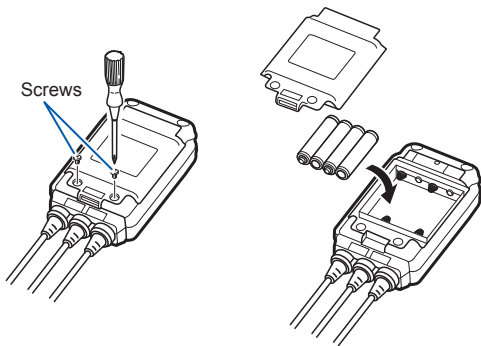

2.5 Inspecting the Instrument

Before using the instrument, inspect it for any damage it may have sustained during storage or shipment and verify its proper operation. If you find any damage, contact your authorized Hioki distributor or reseller.

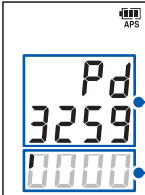
Inspection item	Action
The display shows an error.	Contact your authorized Hioki distributor or reseller.
Are there any cracks or other damage?	The instrument's insulation may have been compromised. Avoid using the instrument due to the risk of electric shock and have it repaired.
Is the cables' insulation damaged, or is any metal exposed?	If there is any damage, avoid using the instrument due to the risk of electric shock and have it repaired.
Are the batteries dead?	Replace the batteries. (p.22)
Is the screen displayed when the instrument is turned on?	The batteries may be dead. Replace them with new batteries and check again.
Does the display show "Pd3259" and a starting animation when the instrument is turned on?	Check the error codes (p.53) <div style="text-align: center; margin-top: 20px;">  <p>The diagram shows a digital display with four lines. The top line shows a battery level icon and 'APS'. The second line shows 'Pd'. The third line shows '3259'. The bottom line shows a starting animation of four vertical bars. Blue lines with dots point from the text 'Pd3259' and 'Starting animation' to the corresponding elements on the display.</p> </div>

2.6 Turning the Instrument On and Off

Press **POWER** to turn the instrument on and off.

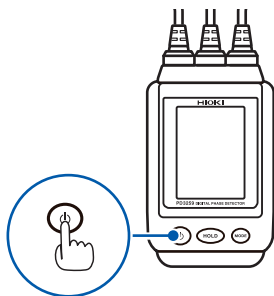

2.7 Attaching the Voltage Sensors to the Circuit

Proper attachment method

Align the mark on each voltage sensor to the insulated target wire and clip it securely in place. The sensors can be attached to wires with diameters ranging from 6 mm to 30 mm.

⚠ DANGER



To prevent electric shock, do not touch the clips in front of the barrier during use.

Example: When measuring a thick insulated wire

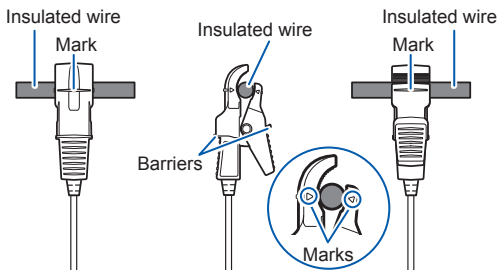

Example: When measuring a thin insulated wire

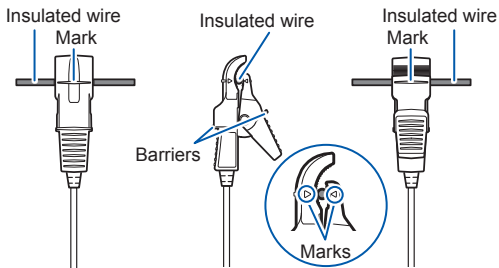

Improper attachment

If the clips are not attached properly, accurate measurement will be impossible due to the effects of nearby wires.

The sensor is attached to the insulated wire by the tip of the clip.

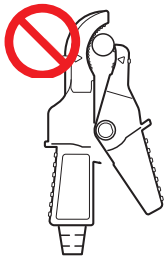

The sensor is attached to the insulated wire at an angle.

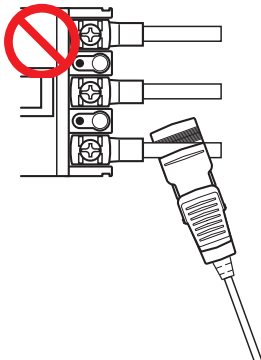

The insulated wire has been inserted too far into the clip.

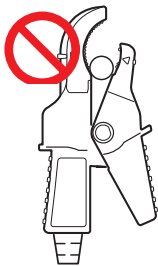

The sensor has been clipped simultaneously to two insulated wires that are carrying different voltages.

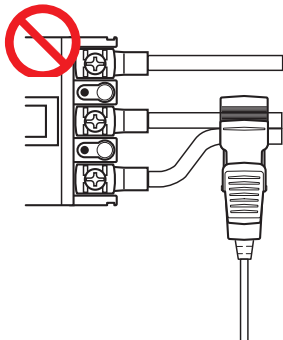

IMPORTANT

If the measurement target is an insulated wire with dirt or moisture on its insulation, the instrument may display lower values than the actual voltage. If the surface of the measurement target's insulation has dirt or moisture on it, wipe it clean with a dry cloth before measurement.

2.8 Setting Up the Instrument in the Measurement Location

Attach voltage sensor R (1) to phase R (1), voltage sensor S (2) to phase S (2), and voltage sensor T (3) to phase T (3).

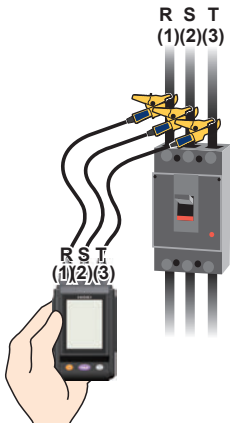

Measurement while holding the instrument

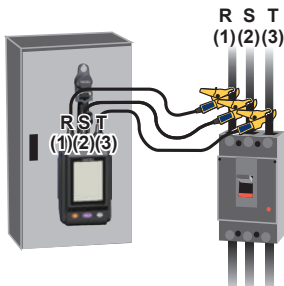

Measurement using the Z5004 Magnetic Strap

Line naming conventions

The three phases are known by various conventions.

<Examples>

First phase	Second phase		Third phase
R	S	T	
L1	L2	L3	
A	B	C	
U	V	W	

Attach voltage sensor R (1) to the first phase of the 3-phase circuit, voltage sensor S (2) to the second phase, and voltage sensor T (3) to the third phase.

3

Performing Measurement

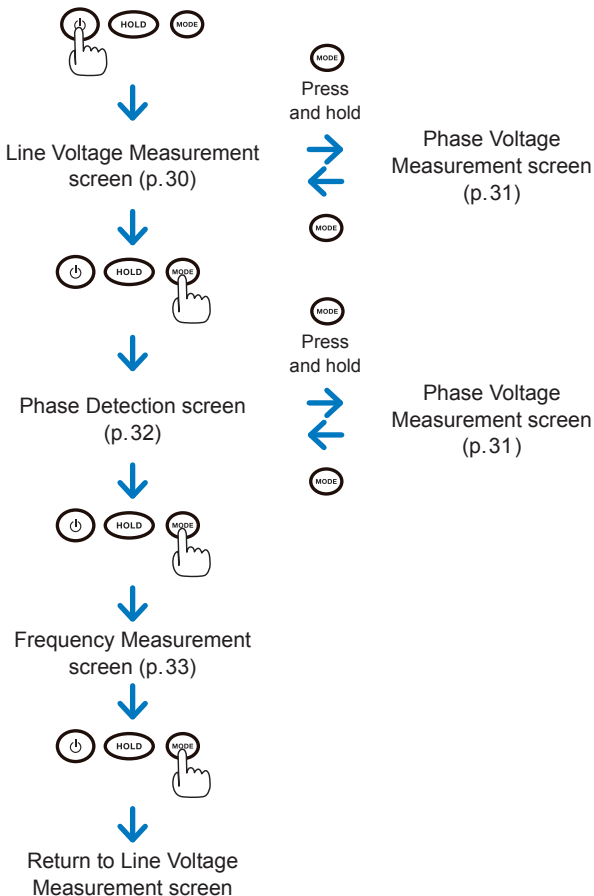

3.1 Measuring Line Voltages in a 3-phase Circuit

Three-phase line voltage measurement

The display will indicate V_{RS} , V_{ST} , and V_{TR} (or V_{1-2} , V_{2-3} , and V_{3-1}). When a 3-phase circuit is measured, the three line voltage values will be shown on the display.

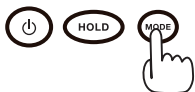

- 1 Display the Line Voltage Measurement screen.
(The Line Voltage Measurement screen is displayed first when the instrument turns on.)



- 2 Check the voltage values.

The display will indicate [Lo] if the line voltage is less than 30.0 V or [ovEr] if the line voltage exceeds 600.0 V.

The instrument not only measures 3-phase circuit, but also line voltage between voltage sensors.

Phase voltage measurement (reference values)

The display will indicate V_R , V_S , and V_T (or V_1 , V_2 , and V_3). When a 3-phase circuit is measured, the three phase voltage values will be shown on the display. However, since the neutral line cannot be measured, the displayed values indicate each phase's voltage relative to the ground using the virtual neutral point (ground) as the reference.

The displayed phase voltages are reference values whose accuracy is not guaranteed.

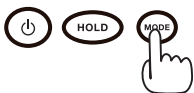

- 1 Display the Line Voltage Measurement screen.**
(The Line Voltage Measurement screen is displayed first when the instrument turns on.)

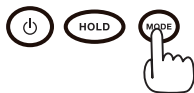

Press and hold

- 2 Press and hold **MODE**.**
(The Phase Voltage Measurement screen will be displayed.)

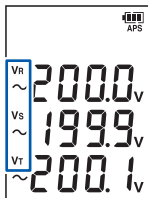

- 3 Check the displayed values.**

The display will indicate **[Lo]** if the phase voltage is less than 30.0 V or **[ovEr]** if the phase voltage exceeds 400.0 V.

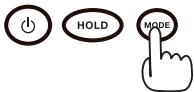

- 4 Press **MODE**.**
(The Line Voltage Measurement screen will be displayed.)

3.2 Checking Phase Order in a 3-phase Circuit (Phase Detection Function)

The instrument displays phase detection results when a 3-phase circuit is measured. The display's backlight will light up, and the instrument will beep to indicate the phase detection results. However, the tone will not sound if the beep setting is disabled (p.40).

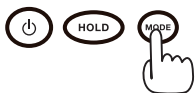

- 1 Display the Phase Detection screen (p.29).



Yellow
Green



- 2 Check the Phase Detection screen.

Normal phase

The display will indicate **POS**, , and .

The display's backlight will turn yellow-green, and the instrument will beep intermittently.



Red



Reversed phase

The display will indicate **REV**, , and .

The display's backlight will turn red, and the instrument will beep continuously. (The instrument will stop beeping automatically after 10 sec. or once the hold function is enabled.)

If unable to detect the phases, the display will not indicate **POS**, **REV**, or an arrow.

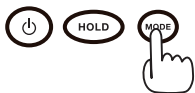

- 3 Press **MODE** twice.
(The Line Voltage Measurement screen will be displayed.)

3.3 Measuring Frequency

The instrument will measure the frequency of the line voltage V_{RS} .

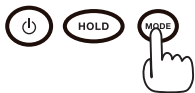

- 1 Display the Frequency Measurement screen (p.29).

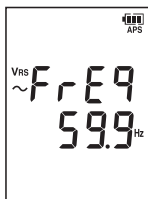

- 2 Check the measured value. (The frequency of the line voltage VRS will be displayed.)

The display will indicate **[Lo]** if the measured frequency is less than 45.0 Hz or **[ovEr]** if the frequency exceeds 66.0 Hz.

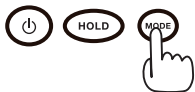

- 3 Press **MODE**. (The Line Voltage Measurement screen will be displayed.)

During frequency measurement, only the line voltage VRS frequency is measured. Specifically, the instrument measures the differential signal between voltage sensor R (1) and voltage sensor S (2).

4

Convenient Uses

4.1 Power-on Options

Power-on options can be set as described below. (Perform the indicated operation while the instrument is turned off.)

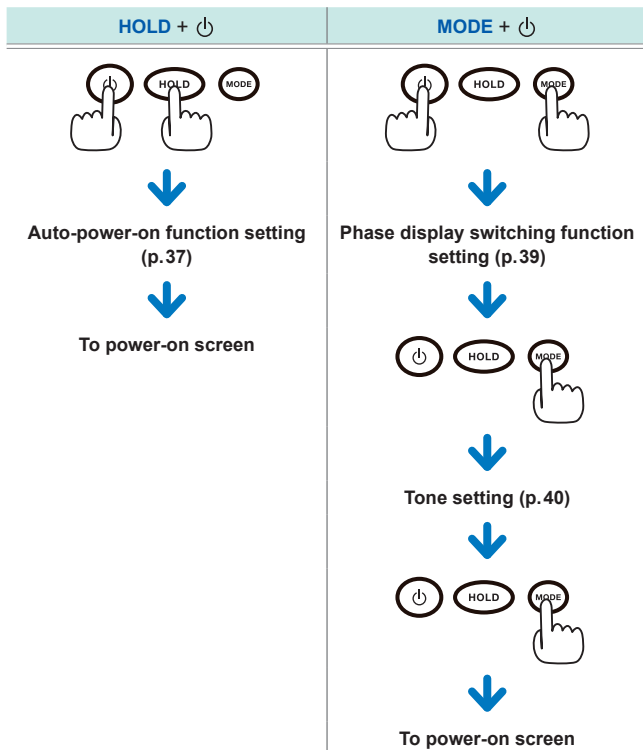

HOLD + MODE + ⏻

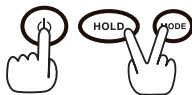

Display version information (p.41)

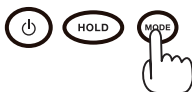

Display serial number (p.41)

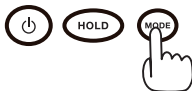

To power-on screen

Auto power-off function

The instrument provides functionality for limiting battery consumption. When the auto-power-off function is enabled, the instrument will automatically turn off once 10 min. has passed since the last key operation. (It will beep intermittently starting 30 sec. before the power turns off.)



The **[APS]** icon will be displayed.
(Indicating that auto-power-off is enabled)

The auto-power-off function is enabled when the instrument is turned on normally. The function can also be disabled using power-on options. (p.38)

Disabling the auto-power-off function

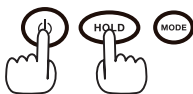

Turn on the instrument while holding down **HOLD**.



[APS OFF] will be displayed.



The power-on screen will be displayed.



The **[APS]** icon will no longer be displayed.
(Indicating that auto-power-off is disabled)

Switching the phase display (phase display switching function)

You can select whether to display phases using the R S T or the 1 2 3 convention.

Phase display	R S T	1 2 3
Line voltage display	V _{RS} , V _{ST} , V _{TR}	V ₁₋₂ , V ₂₋₃ , V ₃₋₁

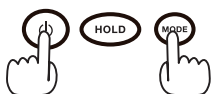

- 1 Turn on the instrument while holding down **MODE**.

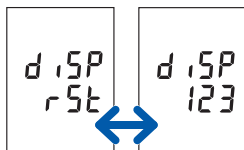

- 2 Press **HOLD** to select the phase display ([rst] ↔ [123]).



- 3 Press **MODE**.

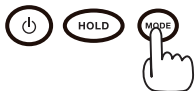

- 4 Press **MODE** again.
(After the power-on screen is displayed, the instrument will display the Line Voltage Measurement screen.)

The phase display switching function setting will take effect the next time the instrument is turned on.

Enabling and disabling the beep function

This section describes how to enable or disable the beeping tones that the instrument emits during key operation and phase detection.

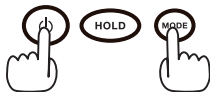

- 1** Turn on the instrument while holding down **MODE**.

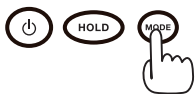

- 2** Press **MODE**.

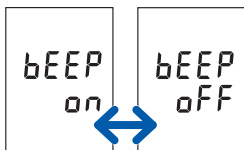

- 3** Press **HOLD** to select whether to enable or disable the beep function ([on]↔[oFF]).

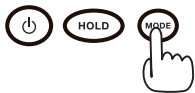
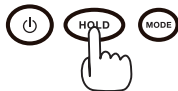

- 4** Press **MODE**.
(After the power-on screen is displayed, the instrument will display the Line Voltage Measurement screen.)

The beep function setting will take effect the next time the instrument is turned on.

Checking the version and serial number

This section describes how to display version information along with the instrument's serial number.

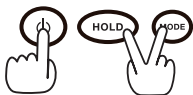

- 1 Turn on the instrument while holding down **HOLD** and **MODE** at the same time.



The display will indicate **[vEr]**.

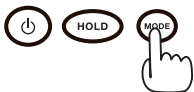

- 2 Press **MODE**.

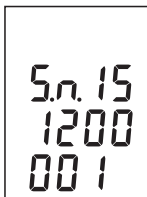

- 3 Check the serial number.

Example: Serial number "151200001"

The serial number consists of 9 digits. The first two (from the left) indicate the year of manufacture, and the next two indicate the month of manufacture.

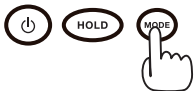

- 4 Press **MODE**.
(After the power-on screen is displayed, the instrument will display the Line Voltage Measurement screen.)

4.2 Holding the Display

This section describes how to hold measured values and phase detection results shown on the display. The hold function can be used on the Voltage Measurement screen, Phase Detection screen, and Frequency Measurement screen.

Enabling and disabling the hold function

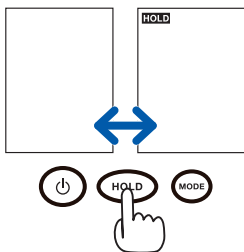

Press **HOLD** to select whether to enable or disable the hold function.

When **[HOLD]** is not shown (during normal operation):

The hold function is disabled.

When **[HOLD]** is shown:

The hold function is enabled.

(Measured values and detection results will be held.)

When normal phase is detected and when the instrument is unable to detect the phase, the yellow-green backlight will turn on. When reversed phase is detected, the red backlight will turn on.

4.3 Turning On the Backlight

This section describes how to turn on the backlight. The backlight makes it possible to view the display clearly in dim locations where the LCD would otherwise be difficult to see.

Enabling and disabling the backlight

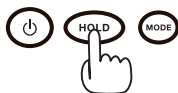

Press and hold **HOLD**.
(To select whether to enable or disable the backlight.)

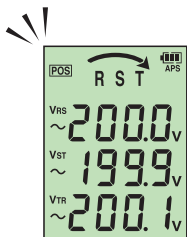

Ordinarily the yellow-green backlight turns on. The red backlight turns on only when reversed phase is detected.

The backlight automatically turns off 30 sec. after turning on, regardless of the hold function or screen transitions. However, when phase detection results are being displayed on the Phase Detection screen, the backlight color will change to reflect the phase detection results after 30 sec.

4.4 Displaying the Predicted State for a 3-phase Circuit

When measuring a 3-phase circuit with Δ wiring in which one phase is grounded, the PD3259 can automatically predict the grounded phase. In addition, the instrument can predict if one line of the 3-phase circuit is missing. The results are shown using icons on the display (These functions are only used in Japan.)

3-phase/3-wire

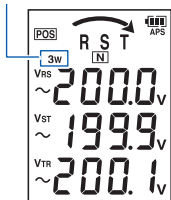

Ground phase prediction

If the S phase is grounded, the display will indicate **N** underneath **S**. Similarly, if the R phase is grounded, the display will indicate **N** underneath **R**, and if the T phase is grounded, the display will indicate **N** underneath **T**. (Similar displays are used if 1/2/3 numbering is used for the phase display.)



Missing phase prediction

If the instrument predicts that one wire of the 3-phase circuit is missing, the icon for the phase predicted to be missing (**R S T** or **1 2 3**) will not be displayed.

Proper identification of the ground phase or missing phase is not guaranteed. Results may be inaccurate if the circuit incorporates complex wiring or if the distance from the point of measurement to the break in the wire meets certain criteria.

5

Specifications

5.1 General Specifications

Operating environment	Indoors, Pollution Degree 2, altitude up to 2000 m (6562 ft.)
Operating temperature and humidity	Temperature: -25°C to 65°C (-13°F to 149°F) Humidity: 80% RH or less at less than 50°C (no condensation) 50% RH or less at 50°C to 65°C (no condensation)
Storage temperature and humidity	-25°C to 65°C (-13°F to 149°F), 80% RH or less (no condensation)
Dust-proof, water-proof	Instrument (excluding voltage sensor): IP54 (EN 60529)
Standards	Safety: EN61010 EMC: EN61326 Class A
Dielectric strength	7.4 kV AC (sensed current: 1 mA) Between voltage sensor opening and instrument enclosure
Power supply	LR6 (AA-size) alkaline battery × 4 Rated supply voltage: 1.5 V DC × 4 Maximum rated power: 3 VA
Continuous operating time	When using LR6 (AA-size) alkaline battery × 4 (reference value at 23°C) Approx. 5 hr. (with display backlight off and instrument in standby state)
Dimensions	Instrument: Approx. 84W × 146H × 46D mm (3.31"W × 5.75"H × 1.81"D)
Cable length	Approx. 0.5 m
Mass	Approx. 590 g (20.8 oz.) (including batteries)
Product warranty period	3 years
Accessories	See p. 1.

Options	See p.2.
----------------	----------

5.2 Input Specifications and Measurement Specifications

Basic specifications

Measurement parameters	3-phase AC voltage (line voltage, voltage relative to ground), frequency
Measurement targets	Insulated wires*, metal parts* *Not compatible with shielded wires. 3-phase 90.0 V AC to 520.0 V AC (45 Hz to 66 Hz)
Measurable conductor diameter	Outer diameter: ϕ 6 mm to 30 mm
Voltage detection method	Coupled capacitance cancellation method
Voltage sensor rated voltage	400 V AC relative to ground per voltage sensor circuit
Voltage measurement method	Digital sampling, true RMS method
Measurement display	4-digit 7-segment LCD \times 3
Response time	3 sec. or less
Display update rate	500 \pm 10 ms
Maximum rated input to ground voltage	600 V AC (CAT IV) Anticipated transient overvoltage: 8000 V

Accuracy specifications

Conditions of guaranteed accuracy	Guaranteed accuracy period: 1 year Guaranteed accuracy period from adjustment made by Hioki: 1 year Temperature and humidity for guaranteed accuracy: 23°C ±5°C (73°F ±9°F), 80% RH or less Warm-up time: Max. 10 sec. Number of voltage sensor clip open/close cycles: 8,000 or less
Line voltage measurement accuracy	±2.0% rdg. ±8 dgt. (1-year accuracy) ±3.0% rdg. ±8 dgt. (3-year accuracy; reference value)
Frequency measurement accuracy	±0.5% rdg. ±1 dgt.
Effects of external magnetic fields	Within ±6.0 V for 400 A/m AC (50 Hz/60 Hz) field
Effects of nearby wires	Add ±4.0 V to measured voltage values. (Value describes effect when an adjacent wire with a potential difference of 400 V AC is in contact with the voltage sensor's clip.)
Temperature coefficient	±0.4 V/°C (at other than 23°C ±5°C)
Effects of humidity	Add ±4.0 V to measured voltage values. (When measuring insulated wires at a humidity level of 70% RH to 80% RH)
Line voltage phase difference shift	Equivalent to ±2.6°

5.3 Functional Specifications

Phase detection function	Normal (positive) phase, reversed (negative) phase (3-phase/3-wire, 3-phase/4-wire)
---------------------------------	---

Missing phase prediction function	Predicts missing phase.
--	-------------------------

5.4 Other Specifications

Hold function	Displayed values are held when the HOLD key is pressed.
----------------------	--

Display backlight function	The display is illuminated by a yellow-green backlight when the hold function is enabled. However, the backlight will turn red when reversed phase is detected. Pressing and holding the HOLD key activates the backlight. Backlight time: Max. 30 sec. ± 2 sec.
-----------------------------------	---

Beep function	Key tone: Single tone When normal phase is detected by phase detection function: Intermittent tone When reversed phase is detected by phase detection function: Continuous tone (max. 10 sec. ± 1 sec.) (The beep function can be muted.)
----------------------	--

Auto-power-off function	The instrument automatically turns off approximately 10 min. after the last key operation. (The auto-power-off function can be disabled.)
--------------------------------	--

Low battery warning	Displays the remaining battery strength (in 4 levels)
----------------------------	---

Drop-proof	The instrument can withstand being dropped onto a concrete surface from a height of 1 m.
-------------------	--

6

Maintenance and Service

6.1 Repair, Inspection, and Cleaning

IMPORTANT

If the instrument is dirty, wipe it gently with a soft cloth that has been moistened with a small amount of water or neutral detergent.

Disposal

When disposing of the instrument, be sure to adhere to all applicable local regulations.

Calibration

The interval at which the instrument must be calibrated varies with the manner and environment in which it is used. It is recommended to determine the appropriate calibration interval based on the manner and environment in which you intend to use the instrument and then to request Hioki to calibrate it on a regular basis accordingly.

6.2 Troubleshooting

If you encounter an issue with the instrument and believe it may be malfunctioning, review the information provided in “Before having the instrument repaired” below. If unable to resolve the issue, contact your authorized Hioki distributor or reseller.

Before having the instrument repaired

Issue	What to check	Solution	More information
The screen does not show anything when the instrument is turned on.	Have batteries been properly installed in the instrument?	Check the type of battery in use and the orientation in which they have been installed.	p.22
	Are the batteries dead?	Replace the spent batteries with new batteries.	p.22
Measured values are not displayed.	Have the voltage sensors been properly attached to the measurement targets (wires)?	Check how the voltage sensors have been attached to the wires.	p.25
	Have multiple voltage sensors been attached to the same measurement target (wire)?	Attach each voltage sensor to only one wire.	p.25

Issue	What to check	Solution	More information
Measured values fail to stabilize.	Is the measurement target's frequency 50 Hz or 60 Hz? The instrument does not support 400 Hz frequency as a line frequency.	The instrument is designed exclusively for use with 50 Hz and 60 Hz circuits. (The accuracy guarantee only applies to the frequency range of 45 Hz to 66 Hz.) The instrument cannot be used to measure 400 Hz circuits accurately.	-

Issue	What to check	Solution	More information
Phase detection results fail to stabilize.	Is the measurement target's frequency 50 Hz or 60 Hz? The instrument does not support the frequency of 400 Hz.	The instrument is designed exclusively for use with 50 Hz and 60 Hz circuits. (The accuracy guarantee only applies to the frequency range of 45 Hz to 66 Hz.) The instrument cannot be used to measure 400 Hz circuits accurately.	-
	Have the voltage sensors been properly attached to the measurement targets (wires)?	Check how the voltage sensors have been attached to the wires.	p.25
	Have multiple voltage sensors been attached to the same measurement target (wire)?	Attach each voltage sensor to only one wire.	p.25
The instrument displays lower values than the actual voltage.	Does the insulated wire of the measurement target have any dirt or moisture on it?	Wipe it clean with a dry cloth before measurement.	-

Error codes

Error display	Description	Solution
Err 001	ROM error program	Take the following action if the display indicates an error: Replace the batteries with new batteries (p.22). If this fails to resolve the issue, the instrument needs to be repaired.
Err 002	ROM error adjustment data	
Err 003	ADC error Hardware failure	

Appendix

Appx. 1 About 3-phase Circuits

3-phase 400 V lines

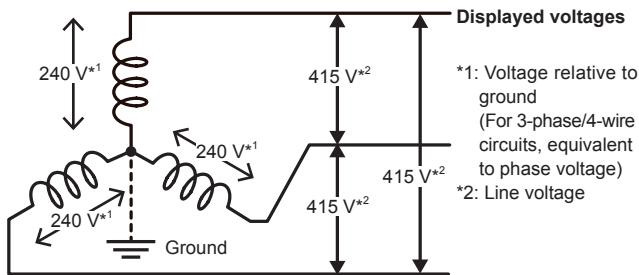

The 400 V lines depicted in the figure have a line voltage of 415 V yet have a voltage relative to ground of approximately 240 V. It is possible to measure this circuit using a measuring instrument rated for an input-to-ground voltage of 300 V.

The PD3259's input-to-ground voltage rating of 400 V enables it to be safely be used to measure lines with a line voltage of 415 V.

Appx. 2 About the Instrument's Voltage Sensors

Each of the instrument's voltage sensors incorporates an internal electrode (metal plate). When the voltage sensor is clipped around the measurement target (wire), the minuscule current I flows due to capacitive coupling between the measurement target and the voltage sensor's internal electrode.

$$I = 2\pi fCV \quad (1)$$

f : Frequency of measurement target [Hz]

C : Capacitance between measurement target and voltage sensor's internal electrode [F]

V : Voltage (AC) between the measurement target and the voltage sensor's internal electrode [V]

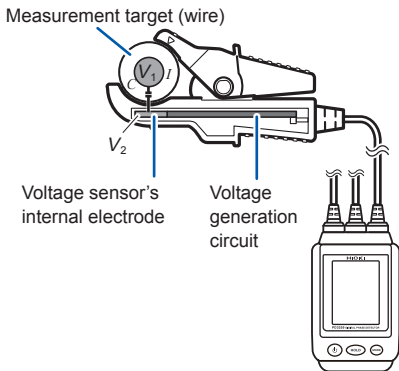

V_2 is controlled so that $I = 0$.

Since $V_1 = V_2$ when $I = 0$, V_2 is measured to obtain V_1 .

Based on equation (1), $I = 0$ when $V = 0$ (when the measurement target and the voltage sensor's internal electrode are at the same potential).

The instrument's voltage sensors detect the minuscule current I , and the voltage of the voltage sensor's internal electrode is controlled so that $I = 0$. The same voltage (V_2) as the measurement target's voltage (V_1) is generated internally by the sensor.

The instrument implements a voltage measurement method that does not require contact with exposed metal surfaces on the measurement target by measuring the voltage generated internally by the voltage sensor (V_2) when $V_1 = V_2$. (This method is known as the coupled capacitance cancellation method.)

About the Instrument's Voltage Sensors

Index

A

- APS 16
- Auto-power-off function .. 16, 37
 - Disabling auto-power-off function 38

B

- Barriers 14, 15, 25
- Battery level display..... 17
- Beeping tones..... 40

C

- Cables 9
- Clip 15
- Coupled capacitance cancellation method..... Appx.3

D

- Display 16

H

- HOLD..... 16
- Hold function..... 42

I

- Insulated wire 46
- Interruption of power..... 17

L

- Line voltage 16
- LR6 (AA-size) alkaline batteries..... 1

M

- Magnetic strap 2, 21
- Measuring frequency 33
- Measuring line voltages in a 3-phase circuit 30

N

- Normal (positive) phase..... 32

O

- Options 2

P

- Phase detection..... 16
- Phase display 16, 39
- Phase voltage..... 31
- POS 16
- POWER..... 24

R

- REV 16
- Reversed (negative) phase .. 32

S

- Spiral tubes..... 1

V

Voltage sensor..... 15

Warranty Certificate

HIOKI

Model	Serial number	Warranty period Three (3) years from date of purchase (___ / ___)
-------	---------------	--

Customer name: _____

Customer address: _____

Important

- Please retain this warranty certificate. Duplicates cannot be reissued.
- Complete the certificate with the model number, serial number, and date of purchase, along with your name and address. The personal information you provide on this form will only be used to provide repair service and information about Hioki products and services.

This document certifies that the product has been inspected and verified to conform to Hioki's standards.

Please contact the place of purchase in the event of a malfunction and provide this document, in which case Hioki will repair or replace the product subject to the warranty terms described below.

Warranty terms

- The product is guaranteed to operate properly during the warranty period (three [3] years from the date of purchase).
If the date of purchase is unknown, the warranty period is defined as three (3) years from the date (month and year) of manufacture (as indicated by the first four digits of the serial number in YYMM format).
- If the product came with an AC adapter, the adapter is warranted for one (1) year from the date of purchase.
- The accuracy of measured values and other data generated by the product is guaranteed as described in the product specifications.
- In the event that the product or AC adapter malfunctions during its respective warranty period due to a defect of workmanship or materials, Hioki will repair or replace the product or AC adapter free of charge.
- The following malfunctions and issues are not covered by the warranty and as such are not subject to free repair or replacement:
 - Malfunctions or damage of consumables, parts with a defined service life, etc.
 - Malfunctions or damage of connectors, cables, etc.
 - Malfunctions or damage caused by shipment, dropping, relocation, etc., after purchase of the product
 - Malfunctions or damage caused by inappropriate handling that violates information found in the instruction manual or on precautionary labeling on the product itself
 - Malfunctions or damage caused by a failure to perform maintenance or inspections as required by law or recommended in the instruction manual
 - Malfunctions or damage caused by fire, storms or flooding, earthquakes, lightning, power anomalies (involving voltage, frequency, etc.), war or unrest, contamination with radiation, or other acts of God
 - Damage that is limited to the product's appearance (cosmetic blemishes, deformation of enclosure shape, fading of color, etc.)
 - Other malfunctions or damage for which Hioki is not responsible
- The warranty will be considered invalidated in the following circumstances, in which case Hioki will be unable to perform service such as repair or calibration:
 - If the product has been repaired or modified by a company, entity, or individual other than Hioki
 - If the product has been embedded in another piece of equipment for use in a special application (aerospace, nuclear power, medical use, vehicle control, etc.) without Hioki's having received prior notice
- If you experience a loss caused by use of the product and Hioki determines that it is responsible for the underlying issue, Hioki will provide compensation in an amount not to exceed the purchase price, with the following exceptions:
 - Secondary damage arising from damage to a measured device or component that was caused by use of the product
 - Damage arising from measurement results provided by the product
 - Damage to a device other than the product that was sustained when connecting the device to the product (including via network connections)
- Hioki reserves the right to decline to perform repair, calibration, or other service for products for which a certain amount of time has passed since their manufacture, products whose parts have been discontinued, and products that cannot be repaired due to unforeseen circumstances.

HIOKI E.E. CORPORATION

<http://www.hioki.com>

18-07 EN-3

HIOKI

<http://www.hioki.com>



**Our regional
contact
information**

HEADQUARTERS

81 Koizumi
Ueda, Nagano 386-1192 Japan

HIOKI EUROPE GmbH

Rudolf-Diesel-Strasse 5
65760 Eschborn, Germany
hioki@hioki.eu

1808EN

Edited and published by HIOKI E.E. CORPORATION

Printed in Japan

- CE declarations of conformity can be downloaded from our website.
- Contents subject to change without notice.
- This document contains copyrighted content.
- It is prohibited to copy, reproduce, or modify the content of this document without permission.
- Company names, product names, etc. mentioned in this document are trademarks or registered trademarks of their respective companies.



INSTRUMENTOS DE MEDICIÓN INDUSTRIAL



LLÁMANOS

+52(81) 8115-1400 / +52 (81) 8173-4300

LADA Sin Costo:
01 800 087 43 75

E-mail:
ventas@twilight.mx

www.twilight.mx